

CONDICIONES GENERALES

Forma de pago

- La forma de pago no deberá sobrepasar los 30 o 60 días con la fecha de la factura. Cualquier aplazamiento del pago de una factura, originará un cargo por gastos de demora.
- La primera compra, siempre se abonará al contado.
- Las formas de pago son giro y pagare otras formas consultar.

Portes

- Cuando la venta sea inferior a 300 € netos, se cobrarán 9 € en concepto de portes.

Devoluciones

- No se admitirán devoluciones sin previo aviso y aceptación de la empresa.
- Las devoluciones, pasados 10 días a partir de la fecha del albarán, tendrán un 10% de recargo.
- Los trabajos a medida no tendrán devolución.
- Las Baterías de PPR no tendrán devolución.
- Las devoluciones siempre serán a cargo del cliente bien por agencia de transporte o por sus medios, enviarlo a nuestras instalaciones, nosotros no recogemos devoluciones.
- Los materiales que ya estén usados o deteriorados no tendrán devolución.

Precios

- Los precios de la presente tarifa están sujetos a modificaciones constantes debido al continuo cambio de precios en el mercado.
- Podemos cambiar precios o descuentos, según el mercado nos lo exija.
- Los impuestos, irán cargados en factura.

Garantía

- Garantizamos todos nuestros artículos de cualquier defecto de fabricación.
- Si el artículo está defectuoso, solamente, se sustituirá la pieza por otra nueva, sin indemnización.
- La garantía de las piezas será de dos años.

Jurisdicción

- Ambas partes se someterán a cualquier litigio en los tribunales de Alcira.

Trabajos a medida

- Cuando nos tengamos que desplazar para medir cualquier tipo de trabajo, llevará un sobrecoste.
- Siempre se enviará el pedido por correo electrónico, con un croquis con medidas de la pieza a fabricar.
- Tendrán un plazo de entrega de aproximadamente 15 días, dependiendo también de la cantidad o dificultad del material a fabricar.
- Cualquier modificación en la pieza a medida, con la original, se le aplicará un recargo.

Diseño

- La empresa puede cambiar el diseño de su producto, siempre para mejora del mismo.
- Cualquier modificación de una pieza standard, se incrementará un 3% sobre su precio.

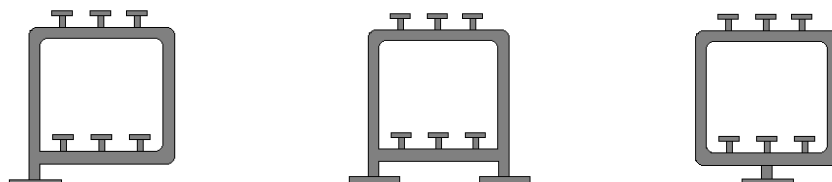

MODELO 2 FILAS BRIDAS

REF.	SALIDAS	A	B	C	E	P.V.P. TIPO P	REF. D.A.	P.V.P. DOBLE A.
142	4	450	420	120	2"	169 €	-	-
162	6	570	420	120	2"	194 €	-	-
182	8	700	420	120	2 ½	267 €	-	-
1102	10	820	420	120	2 ½	294 €	-	-
1122	12	940	420	120	2 ½	320 €	-	-
1142	14	1060	420	120	2 ½	346 €	-	-
1162	16	1180	420	120	2 ½	372 €	-	-
1182	18	1300	420	120	2 ½	399 €	1182DA	435 €
1202	20	1420	420	120	2 ½	424 €	1202DA	460 €
1222	22	1540	420	120	2 ½	449 €	1222DA	485 €
1242	24	1660	420	120	2 ½	472 €	1242DA	510 €
1262	26	1780	420	120	2 ½	503 €	1262DA	540 €
1282	28	1900	420	120	2 ½	531 €	1282DA	565 €
1302	30	2020	420	120	2 ½	554 €	1302DA	590 €

INCLUIDO KIT DE MONTAJE * MEDIDAS EN mm

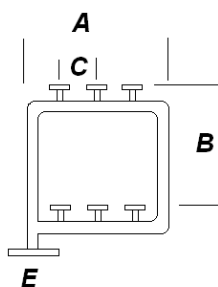

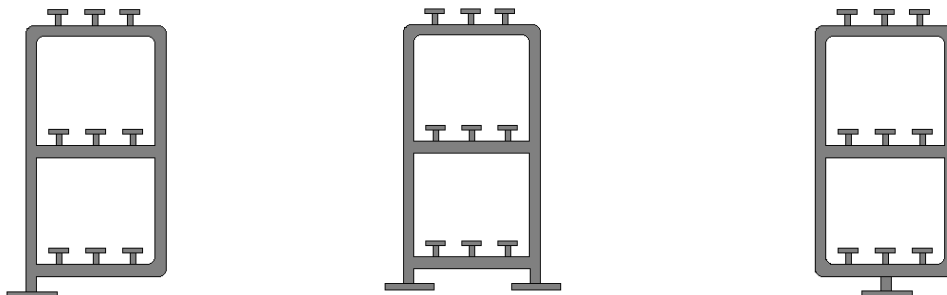

MODELO 3 FILAS BRIDAS

REF.	SALIDAS	A	B	C	D	E	P.V.P. TIPO P	REF. D.A.	P.V.P. DOBLE A.
163	6	450	1070	120	420	2"	232 €	-	-
193	9	580	1070	120	420	2"	341 €	-	-
1123	12	700	1070	120	420	2 ½	376 €	-	-
1153	15	820	1070	120	420	2 ½	416 €	-	-
1183	18	940	1070	120	420	2 ½	458 €	1183DA	495 €
1213	21	1060	1070	120	420	2 ½	496 €	1213DA	530 €
1243	24	1180	1070	120	420	2 ½	535 €	1243DA	570 €
1273	27	1300	1070	120	420	2 ½	575 €	1273DA	610 €
1303	30	1420	1070	120	420	2 ½	612 €	1303DA	650 €
1333	33	1670	1070	120	420	3"	722 €	1333DA	770 €
1363	36	1790	1070	120	420	3"	760 €	1363DA	810 €
1393	39	1910	1070	120	420	3"	800 €	1393DA	850 €
1423	42	2030	1070	120	420	3"	840 €	1423DA	890 €
1453	45	2150	1070	120	420	3"	878 €	1453DA	930 €

INCLUIDO KIT DE MONTAJE *MEDIDAS EN mm

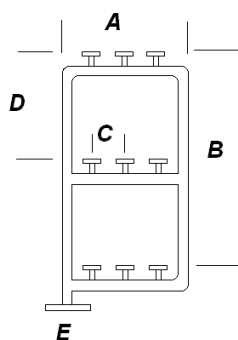

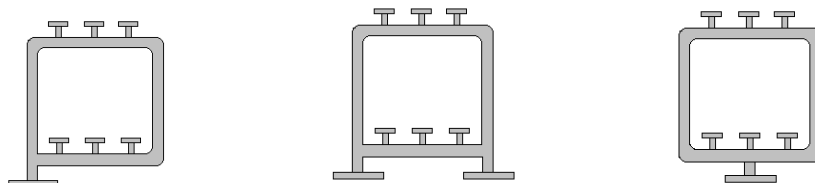

MODELO 2 FILAS BRIDAS ACERO INOXIDABLE

REF.	SALIDAS	A	B	C	E	P.V.P. TIPO P
142i	4	450	420	120	2"	286 €
162i	6	570	420	120	2"	315 €
182i	8	700	420	120	2 ½	358 €
1102i	10	820	420	120	2 ½	399 €
1122i	12	940	420	120	2 ½	432 €
1142i	14	1060	420	120	2 ½	464 €
1162i	16	1180	420	120	2 ½	497 €
1182i	18	1300	420	120	2 ½	514 €
1202i	20	1420	420	120	2 ½	562 €
1222i	22	1540	420	120	2 ½	594 €
1242i	24	1660	420	120	2 ½	629 €
1262i	26	1780	420	120	2 ½	661 €
1282i	28	1900	420	120	2 ½	694 €
1302i	30	2020	420	120	2 ½	727 €

INCLUIDO KIT DE MONTAJE * MEDIDAS EN mm
 * OTROS MODELOS CONSULTAR

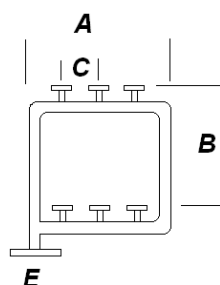

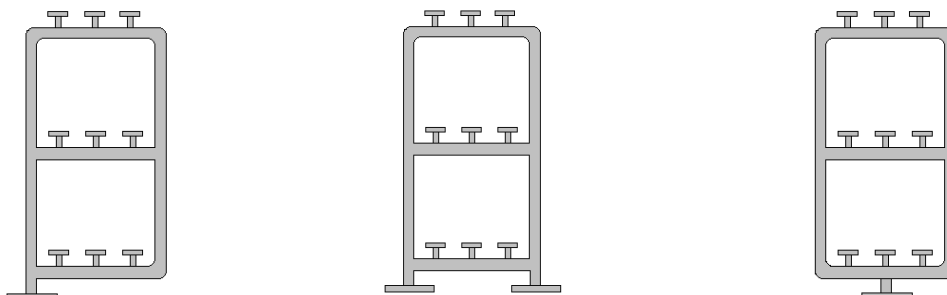

MODELO 3 FILAS BRIDAS ACERO INOXIDABLE

REF.	SALIDAS	A	B	C	D	E	P.V.P. TIPO P
163i	6	450	1070	120	420	2"	419 €
193i	9	580	1070	120	420	2"	464 €
1123i	12	700	1070	120	420	2 ½	508 €
1153i	15	820	1070	120	420	2 ½	553 €
1183i	18	940	1070	120	420	2 ½	600 €
1213i	21	1060	1070	120	420	2 ½	646 €
1243i	24	1180	1070	120	420	2 ½	691 €
1273i	27	1300	1070	120	420	2 ½	736 €
1303i	30	1420	1070	120	420	2 ½	782 €
1333i	33	1670	1070	120	420	3"	982 €
1363i	36	1790	1070	120	420	3"	1038 €
1393i	39	1910	1070	120	420	3"	1117 €
1423i	42	2030	1070	120	420	3"	1173 €
1453i	45	2150	1070	120	420	3"	1253 €

INCLUIDO KIT DE MONTAJE *MEDIDAS EN mm

*OTROS MODELOS CONSULTAR.

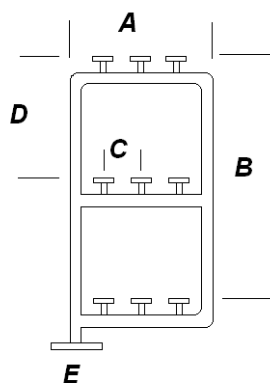

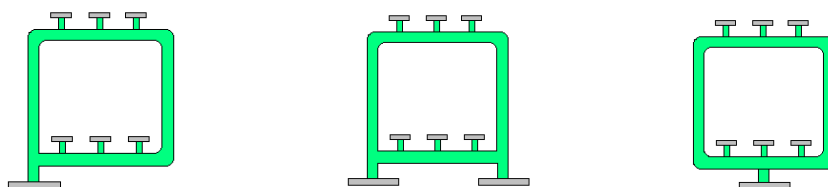

MODELO 2 FILAS BRIDAS

REF.	SALIDAS	A	B	C	E	P.V.P. TIPO P
142P	4	430	420	120	2"	168 €
162P	6	550	420	120	2"	186 €
182P	8	700	420	120	2 ½	214 €
1102P	10	820	420	120	2 ½	232 €
1122P	12	940	420	120	2 ½	260 €
1142P	14	1060	420	120	2 ½	283 €
1162P	16	1180	420	120	2 ½	307 €
1182P	18	1300	420	120	2 ½	317 €
1202P	20	1420	420	120	2 ½	344 €
1222P	22	1540	420	120	2 ½	369 €
1242P	24	1660	420	120	2 ½	387 €
1262P	26	1780	420	120	2 ½	404 €
1282P	28	1900	420	120	2 ½	425 €
1302P	30	2020	420	120	2 ½	449 €

INCLUIDO KIT DE MONTAJE * MEDIDAS EN mm

*OTROS MODELOS CONSULTAR.

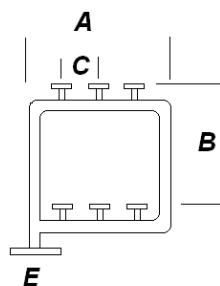

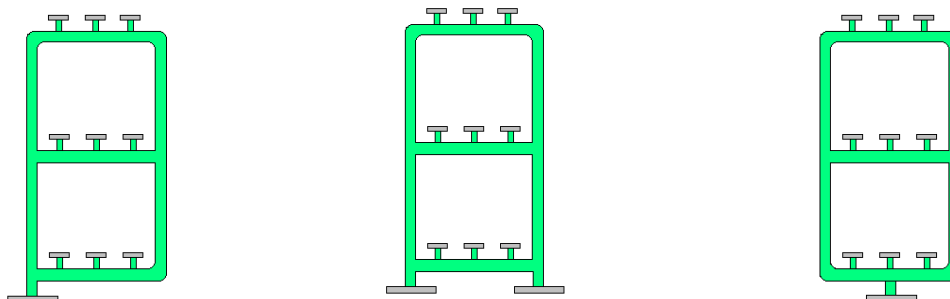

MODELO 3 FILAS BRIDAS

REF.	SALIDAS	A	B	C	D	E	P.V.P. TIPO P
163P	6	430	840	120	420	2"	265 €
193P	9	580	840	120	420	2 ½"	299 €
1123P	12	700	840	120	420	2 ½"	316 €
1153P	15	820	840	120	420	2 ½"	345 €
1183P	18	940	840	120	420	2 ½"	377 €
1213P	21	1060	840	120	420	2 ½"	405 €
1243P	24	1180	840	120	420	2 ½"	432 €
1273P	27	1300	840	120	420	2 ½"	458 €
1303P	30	1420	840	120	420	2 ½"	486 €
1333P	33	1570	840	120	420	3"	662 €
1363P	36	1690	840	120	420	3"	704 €
1393P	39	1810	840	120	420	3"	741 €
1423P	42	1930	840	120	420	3"	785 €
1453P	45	2050	840	120	420	3"	820 €

*INCLUIDO KIT DE MONTAJE * MEDIDAS EN mm

*OTROS MODELOS CONSULTAR.

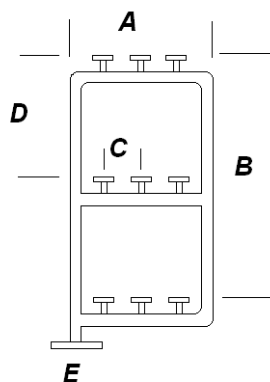

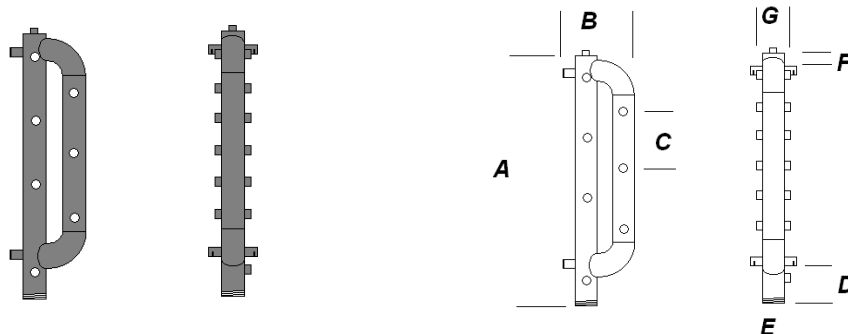

CENTRAL ROSCAS $\frac{3}{4}$

REFERENCIA	Nº TOMAS	A	B	C	D	E	F	G	P.V.P.
42346	6	425	200	220	90	2"	50	90	233 €
42348	8	610	200	220	90	2"	50	90	244 €
4212348	8	620	240	220	90	2 ½	50	90	248 €
423410	10	645	200	220	90	2"	50	90	277 €
42123410	10	670	240	220	90	2 ½	50	90	280 €
423412	12	820	200	220	90	2"	50	90	295 €
42123412	12	850	240	220	90	2 ½	50	90	297 €
42123414	14	880	240	220	90	2 ½	50	90	329 €
42123416	16	1060	240	220	90	2 ½	50	90	364 €
42123418	18	1105	240	220	90	2 ½	50	90	392 €
42123420	20	1280	240	220	90	2 ½	50	90	416 €
42123422	22	1320	240	220	90	2 ½	50	90	452 €
42123424	24	1500	240	220	90	2 ½	50	90	464 €
42123426	26	1350	300	180	90	2 ½	50	90	496 €
42123428	28	1530	300	180	90	2 ½	50	90	527 €
42123430	30	1530	300	180	90	2 ½	50	90	537 €
42123432	32	1660	300	180	90	2 ½	50	90	653 €
42123434	34	1660	300	180	90	2 ½	50	90	678 €

INCLUIDO KIT DE MONTAJE * MEDIDAS EN mm * LAS SALIDAS A 1" 4% DE AUMENTO.
 LAS BATERIAS DE 26, 28, 30, 32 Y 34 TOMAS, VARIAN SUS MEDIDAS PARA NO SUPERAR LO ACONSEJADO EN ALTURA.

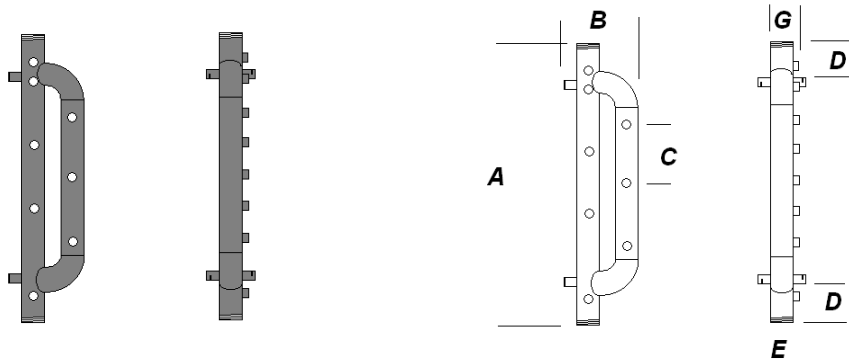

REVERSIBLE ROSCAS $\frac{3}{4}$

REFERENCIA	Nº TOMAS	A	B	C	D	E	F	G	P.V.P.
5112343CC	3	460	160	220	90	1 ½	-	70	146 €
5112344	4	620	160	220	90	1 ½	-	80	188 €
52344	4	650	200	220	90	2"	-	80	191 €
52346	6	860	200	220	90	2"	-	80	255 €
5212346	6	895	240	220	90	2 ½	-	80	258 €
52348	8	1080	200	220	90	2"	-	80	291 €
5212348	8	1110	240	220	90	2 ½	-	80	294 €
523410	10	1300	200	220	90	2 "	-	80	325 €
52123410	10	1340	240	220	90	2 ½	-	80	327 €
523412	12	1520	200	220	90	2 "	-	80	354 €
52123412	12	1550	240	220	90	2 ½	-	80	358 €
52123414	14	1580	300	180	90	2 ½	-	80	390 €

INCLUIDO KIT DE MONTAJE * MEDIDAS EN mm * LAS SALIDAS A 1" 4% DE AUMENTO.
LA BATERIA DE 14 TOMAS, VARIA SUS MEDIDAS PARA NO SUPERAR LO ACONSEJADO EN ALTURA.

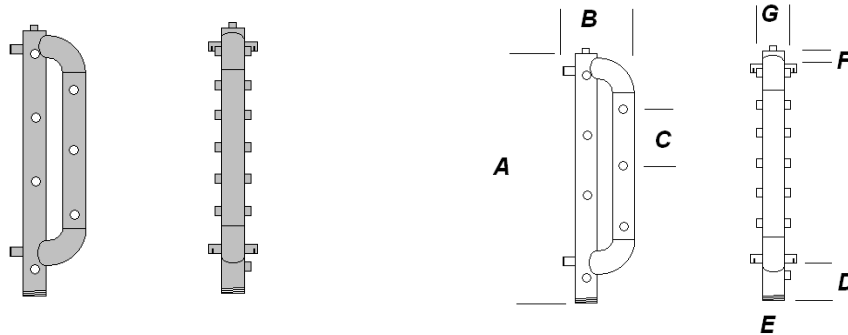

CENTRAL ROSCAS ¾ ACERO INOXIDABLE

REFERENCIA	Nº TOMAS	A	B	C	D	E	F	G	P.V.P.
42346i	6	425	200	220	90	2"	50	90	374 €
42348i	8	610	200	220	90	2"	50	90	385 €
4212348i	8	620	240	220	90	2 ½	50	90	392 €
423410i	10	645	200	220	90	2"	50	90	419 €
42123410i	10	670	240	220	90	2 ½	50	90	462 €
423412i	12	820	200	220	90	2"	50	90	436 €
42123412i	12	850	240	220	90	2 ½	50	90	480 €
42123414i	14	880	240	220	90	2 ½	50	90	498 €
42123416i	16	1060	240	220	90	2 ½	50	90	536 €
42123418i	18	1005	240	220	90	2 ½	50	90	581 €
42123420i	20	1280	240	220	90	2 ½	50	90	625 €
42123422i	22	1320	240	220	90	2 ½	50	90	664 €
42123424i	24	1500	240	220	90	2 ½	50	90	708 €
42123426i	26	1350	300	180	90	2 ½	50	90	749 €
42123428i	28	1530	300	180	90	2 ½	50	90	780 €
42123430i	30	1530	300	180	90	2 ½	50	90	832 €

INCLUIDO KIT DE MONTAJE * MEDIDAS EN mm* LAS SALIDAS A 1" 4% DE AUMENTO.
 LAS BATERIAS DE 26,28 Y 30 TOMAS, VARIAN SUS MEDIDAS PARA NO SUPERAR LO ACONSEJADO EN ALTURA.

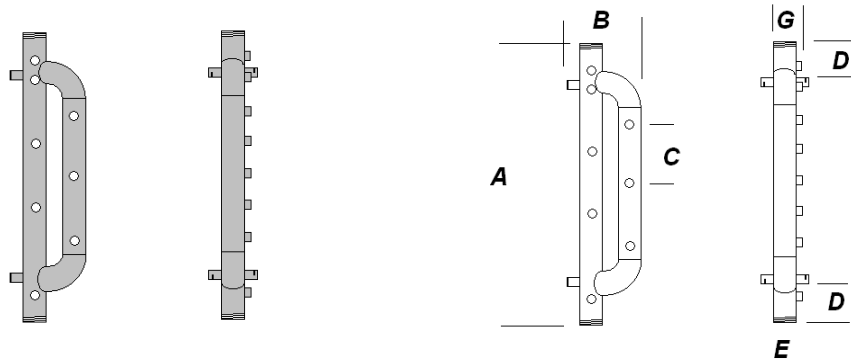

REVERSIBLE ROSCAS ¾ ACERO INOXIDABLE

REFERENCIA	Nº TOMAS	A	B	C	D	E	F	G	P.V.P.
5112343CCi	3	460	160	220	90	1 ½	-	70	299 €
5112344i	4	620	160	220	90	1 ½	-	80	339 €
52344i	4	650	200	220	90	2"	-	80	364 €
52346i	6	860	200	220	90	2"	-	80	386 €
5212346i	6	895	240	220	90	2 ½	-	80	419 €
52348i	8	1080	200	220	90	2"	-	80	411 €
5212348i	8	1110	240	220	90	2 ½	-	80	456 €
523410i	10	1300	200	220	90	2 "	-	80	442 €
52123410i	10	1340	240	220	90	2 ½	-	80	488 €
523412i	12	1520	200	220	90	2 "	-	80	469 €
52123412i	12	1550	240	220	90	2 ½	-	80	540 €
52123414i	14	1580	300	180	90	2 ½	-	80	567 €

INCLUIDO KIT DE MONTAJE * MEDIDAS EN mm* LAS SALIDAS A 1" 4% DE AUMENTO.
LA BATERIA DE 14 TOMAS, VARIA SUS MEDIDAS PARA NO SUPERAR LO ACONSEJADO EN ALTURA.

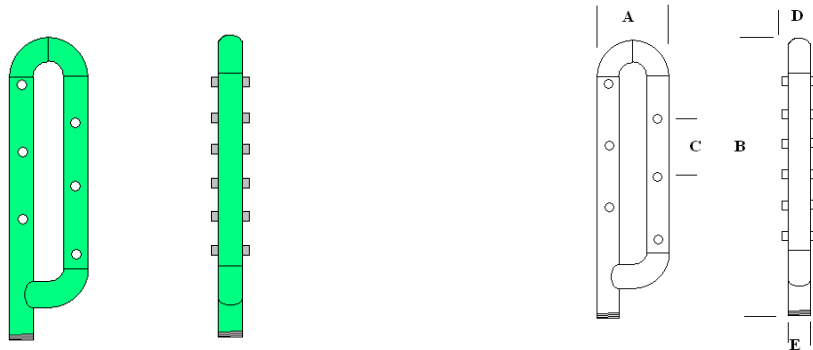

CENTRAL ROSCAS $\frac{3}{4}$

REFERENCIA	Nº TOMAS	A	B	C	D	E	P.V.P.
42346P	6	210	650	220	170	2"	204 €
42348P	8	210	760	220	170	2"	247 €
4212348P	8	250	810	220	190	2 ½	252 €
423410P	10	210	870	220	170	2"	263 €
42123410P	10	250	910	220	190	2 ½	284 €
423412P	12	210	980	220	170	2"	294 €
42123412P	12	250	1020	220	190	2 ½	316 €
42123414P	14	250	1140	220	190	2 ½	340 €
42123416P	16	250	1250	220	190	2 ½	361 €
42123418P	18	250	1360	220	190	2 ½	385 €
42123420P	20	250	1470	220	190	2 ½	369 €
42123422P	22	250	1580	220	190	2 ½	424 €
42123424P	24	250	1690	220	190	2 ½	447 €
42123426P	26	250	1560	180	190	2 ½	469 €
42123428P	28	250	1660	180	190	2 ½	490 €
42123430P	30	250	1730	180	190	2 ½	514 €

INCLUIDO KIT DE MONTAJE * MEDIDAS EN mm* LAS SALIDAS A 1" CONSULTAR.

LAS BATERIAS DE 26,28 Y 30 TOMAS, VARIAN SUS MEDIDAS PARA NO SUPERAR LO ACONSEJADO EN ALTURA.

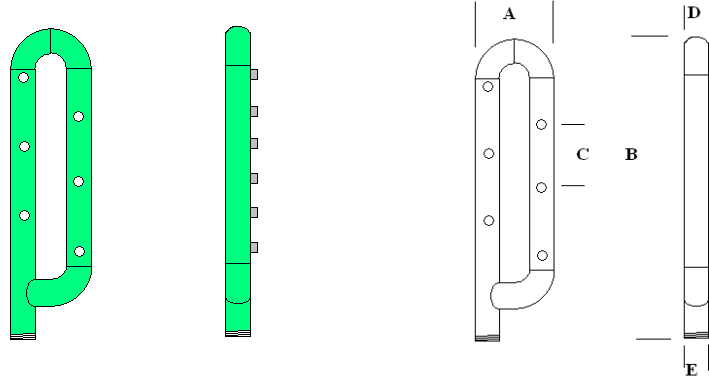

REVERSIBLE ROSCAS $\frac{3}{4}$

REFERENCIA	Nº TOMAS	A	B	C	D	E	P.V.P.
5112343CCP	3	170	580	220	115	1 ½	158 €
5112344P	4	170	690	220	115	1 ½	176 €
52344P	4	210	760	220	130	2"	187 €
52346P	6	210	980	220	130	2"	208 €
5212346P	6	250	1020	220	145	2 ½	248 €
52348P	8	210	1200	220	130	2"	251 €
5212348P	8	250	1250	220	145	2 ½	269 €
523410P	10	210	1420	220	130	2 "	291 €
52123410P	10	250	1460	220	145	2 ½	310 €
523412P	12	210	1640	220	130	2 "	297 €
52123412P	12	250	1680	220	145	2 ½	335 €
52123414P	14	250	1640	180	145	2 ½	356 €

INCLUIDO KIT DE MONTAJE * MEDIDAS EN mm* LAS SALIDAS A 1" CONSULTAR.

LA BATERIA DE 14 TOMAS, VARÍA SUS MEDIDAS PARA NO SUPERAR LO ACONSEJADO EN ALTURA.

ARBOL 1 Y 2 FILAS ROSCAS 3/4

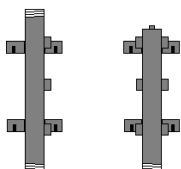

Nº TOMAS	REF. 1 FILA	PVP 1 FILA	REF. 2 FILA	P.V.P.2 FILAS
2	31123421F	51 €	-	-
3	31123431F	80 €	-	-
4	323441F	93 €	323442F	84 €
5	323451F	105 €	-	-
6	323461F	126 €	323462F	112 €
8	32123481F	149 €	32123482F	130 €
10	321234101F	174 €	321234102F	162 €
12	321234121F	208 €	321234122F	195 €
14	-	-	321234142F	227 €
16	-	-	321234162F	260 €
18	-	-	321234182F	292 €
20	-	-	321234202F	324 €

*INCLUIDO KIT DE MONTAJE** LAS SALIDAS A 1" 4% DE AUMENTO
DISTANCIA ENTRE TOMAS 15 cm O MEDIDAS APORTADAS POR EL CLIENTE.

ARBOL 1 Y 2 FILAS EMBRIDADO



Nº TOMAS	REF. 1 FILA	PVP 1 FILA	REF. 2 FILA	P.V.P.2 FILAS
2	311221F	90 €	3222F	81 €
3	311231F	106 €	-	-
4	3241F	136 €	3242F	126 €
5	3251F	150 €	-	-
6	3261F	159 €	3262F	164 €
8	-	-	3282F	199 €
10	-	-	32102F	226 €

*INCLUIDO KIT DE MONTAJE
DISTANCIA ENTRE TOMAS 25 cm.

ARBOL 1 Y 2 FILAS ROSCAS 3/4 ACERO INOXIDABLE

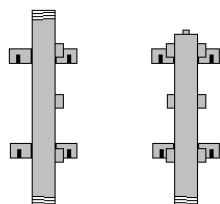

N.º TOMAS	REF. 1 FILA	PVP 1 FILA	REF. 2 FILA	P.V.P.2 FILAS
2	323421Fi	155 €	-	-
3	323431Fi	216 €	-	-
4	323441Fi	270 €	323442Fi	265 €
5	323451Fi	296 €	-	-
6	323461Fi	316 €	323462Fi	312 €
8	32123481Fi	332 €	32123482Fi	327 €
10	321234101Fi	339 €	321234102Fi	337 €
12	321234121Fi	366 €	321234122Fi	365 €
14	-	-	321234142Fi	381 €
16	-	-	321234162Fi	411 €
18	-	-	321234182Fi	442 €
20	-	-	321234202Fi	473 €

*INCLUIDO KIT DE MONTAJE** LAS SALIDAS A 1" 4% DE AUMENTO
 DISTANCIA ENTRE TOMAS 15 cm O MEDIDAS APORTADAS POR EL CLIENTE.

ARBOL 1 Y 2 FILAS EMBRIDADO ACERO INOXIDABLE

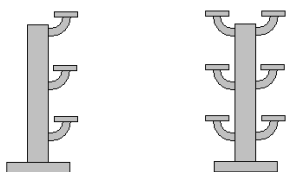

Nº TOMAS	REF. 1 FILA	PVP 1 FILA	REF. 2 FILA	P.V.P.2 FILAS
2	311221Fi	143 €	311222Fi	156 €
3	311231Fi	166 €	-	-
4	3241Fi	193 €	3242Fi	191 €
5	3251Fi	226 €	-	-
6	3261Fi	247 €	3262Fi	235 €
8	3281Fi	298 €	3282Fi	282 €
10	32101Fi	323 €	32102Fi	314 €

*INCLUIDO KIT DE MONTAJE
 DISTANCIA ENTRE TOMAS 25 cm.

ARBOL 1 Y 2 FILAS ROSCAS 3/4

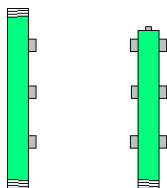

Nº TOMAS	REF. 1 FILA	PVP 1 FILA	REF. 2 FILA	P.V.P.2 FILAS
2	32342PR1F	104 €	-	-
3	32343PR1F	117 €	-	-
4	32344PR1F	132 €	32344PR2F	126 €
5	32345PR1F	146 €	-	-
6	32346PR1F	156 €	32346PR2F	152 €
8	3212348PR1F	266 €	3212348PR2F	239 €
10	32123410PR1F	284 €	32123410PR2F	267 €
12	-	-	32123412PR2F	293 €
14	-	-	32123414PR2F	314 €
16	-	-	32123416PR2F	336 €
18	-	-	32123418PR2F	361 €
20	-	-	32123420PR2F	386 €

*INCLUIDO KIT DE MONTAJE** LAS SALIDAS A 1" 4% CONSULTAR
DISTANCIA ENTRE TOMAS 15 cm O MEDIDAS APORTADAS POR EL CLIENTE.

ARBOL 1 Y 2 FILAS EMBRIDADO

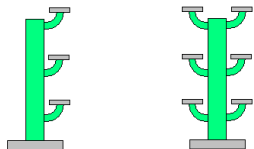

Nº TOMAS	REF. 1 FILA	PVP 1 FILA	REF. 2 FILA	P.V.P.2 FILAS
2	32342PB1F	117 €	32342PB2F	111 €
3	32343PB1F	128 €	-	-
4	32344PB1F	143 €	32344PB2F	138 €
5	32345PB1F	155 €	-	-
6	32346PB1F	167 €	32346PB2F	156 €
8	32348PB1F	266 €	32348PB2F	250 €
10	323410PB1F	296 €	323410PB2F	279 €

*INCLUIDO KIT DE MONTAJE
DISTANCIA ENTRE TOMAS 25 cm.

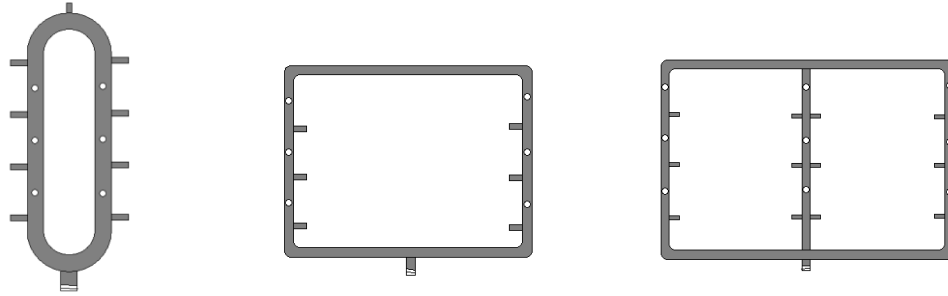

Nº TOMAS	REF OVALADA	PVP OVALADA	REF CUADRADA	PVP CUADRADA	REF. RECTANGULAR	PVP RECTANGULAR
4	82344O	242 €	82344C	278 €	-	-
6	82346O	269 €	82346C	306 €	-	-
8	82348O	286 €	82348C	393 €	-	-
10	823410O	333 €	823410C	369 €	-	-
12	82123412O	358 €	82123412C	394 €	-	-
14	82123414O	395 €	82123414C	429 €	-	-
16	82123416O	425 €	82123416 C	462 €	-	-
18	82123418O	462 €	82123418C	498 €	-	-
20	82123420O	492 €	82123420C	528 €	82123420R	662 €
22	82123422O	533 €	82123422C	558 €	82123422R	703 €
24	82123424O	560 €	82123424C	596 €	82123424R	724 €
26	82123426O	581 €	82123426C	617 €	82123426R	758 €
28	82123428O	617 €	82123428C	654 €	82123428R	788 €
30	82123430O	638 €	82123430C	673 €	82123430R	825 €

LAS TOMAS A 1" Y OTRAS MEDIDAS CONSULTAR* LAS SALIDAS A 1" 4% DE AUMENTO* CIRCUITO 3" MAS 3%
PARA FABRICAR ESTAS BATERIAS, ES NECESARIO APORTAR CROQUIS CON MEDIDAS.

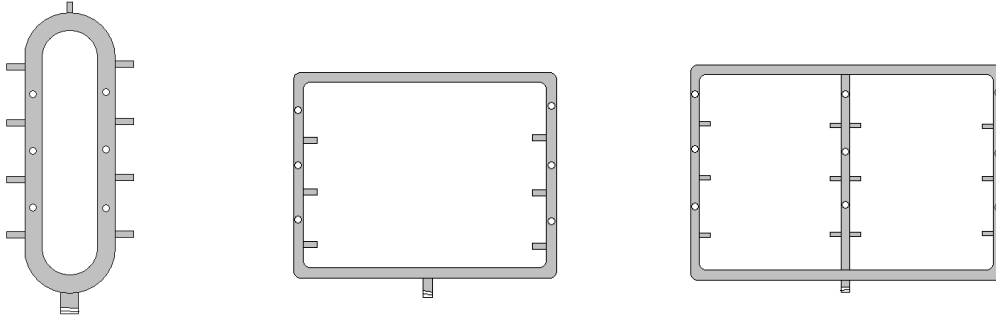

ACERO INOXIDABLE

Nº TOMAS	REF OVALADA	PVP OVALADA	REF CUADRADA	PVP CUADRADA	REF. RECTANGULAR	PVP RECTANGULAR
4	72344O	396 €	72344C	457 €	-	-
6	72346O	546 €	72346C	604 €	-	-
8	72348O	600 €	72348C	659 €	-	-
10	723410O	672 €	723410C	731 €	-	-
12	72123412O	733 €	72123412C	793 €	-	-
14	72123414O	834 €	72123414C	894 €	-	-
16	72123416O	935 €	72123416C	995 €	-	-
18	72123418O	1011 €	72123418C	1071 €	-	-
20	72123420O	1087 €	72123420C	1147 €	72123420R	1175 €
22	72123422O	1163 €	72123422C	1223 €	72123422R	1238 €
24	72123424O	1239 €	72123424C	1260 €	72123424R	1290 €
26	72123426O	1290 €	72123426C	1344 €	72123426R	1377 €
28	72123428O	1366 €	72123428C	1425 €	72123428R	1459 €
30	72123430O	1408 €	72123430C	1468 €	72123430R	1540 €

LAS TOMAS A 1" Y OTRAS MEDIDAS CONSULTAR* LAS SALIDAS A 1" 4% DE AUMENTO* CIRCUITO 3" MAS 3%
PARA FABRICAR ESTAS BATERIAS, ES NECESARIO APORTAR CROQUIS CON MEDIDAS.

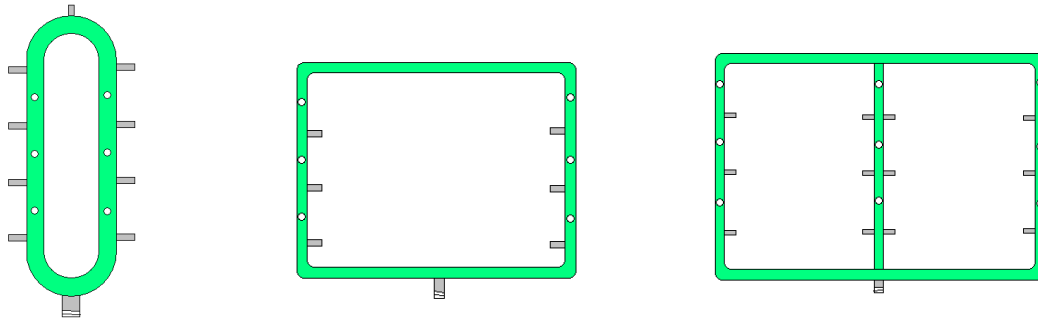

Nº TOMAS	REF OVALADA	PVP OVALADA	REF CUADRADA	PVP CUADRADA	REF. RECTANGULAR	PVP RECTANGULAR
4	82344PO	193 €	82344PC	207 €	-	-
6	82346PO	209 €	82346PC	222 €	-	-
8	82348PO	248 €	82348PC	263 €	-	-
10	823410PO	354 €	823410PC	368 €	-	-
12	82123412PO	381 €	82123412PC	395 €	-	-
14	82123414PO	409 €	82123414PC	424 €	-	-
16	82123416PO	436 €	82123416PC	451 €	-	-
18	82123418PO	464 €	82123418PC	479 €	-	-
20	82123420PO	492 €	82123420PC	506 €	82123420PR	557 €
22	82123422PO	520 €	82123422PC	535 €	82123422PR	589 €
24	82123424PO	547 €	82123424PC	563 €	82123424PR	619 €
26	82123426PO	580 €	82123426PC	593 €	82123426PR	652 €
28	82123428PO	604 €	82123428PC	618 €	82123428PR	680 €
30	82123430PO	630 €	82123430PC	643 €	82123430PR	707 €

LAS TOMAS A 1" Y OTRAS MEDIDAS CONSULTAR* LAS SALIDAS A 1", CONSULTAR CIRCUITO 3". CONSULTAR PARA FABRICAR ESTAS BATERIAS, ES NECESARIO APORTAR CROQUIS CON MEDIDAS.



CODIGO	MODELOS CON RACOR DN15	P.V.P.
6AC34	JUEGO $\frac{3}{4}$ - $\frac{3}{4}$	42 €
6A34R	VÁLVULA ENTRADA BRIDA RACOR $\frac{3}{4}$	25 €
6A34RR	VÁLVULA SALIDA RACOR $\frac{3}{4}$ – RETENC,	17 €



CODIGO	MODELOS CON RACORDN15	P.V.P.
6AC78	JUEGO $\frac{3}{4}$ - 7/8	44 €
6A78R	VÁLVULA ENTRADA BRIDA RACOR 7/8	27 €
6A34RR	VÁLVULA SALIDA RACOR $\frac{3}{4}$ – RETENC,	17 €



CODIGO	MODELO	P.V.P.
63415	$\frac{3}{4}$	4,24 €
67813	7/8	5,10 €



CODIGO	DIÁMETRO	MATERIAL	P.V.P.
6234BR	$\frac{3}{4}$ - $\frac{3}{4}$	VALV. BRIDA H, 3/4	22,66 €

VÁLVULAS Y ACCESORIOS



CODIGO	MODELOS	P.V.P.
634	JUEGO ¾	22,88 €
634R	JUEGO ¾ RETENCION	30,40 €
61	JUEGO 1"	33,60 €
61R	JUEGO 1" RETENCION	44,60 €



CODIGO	MATERIAL	P.V.P.
634RT	JUEGO ¾ RETENCION Y TE	38,58 €
61RT	JUEGO 1" RETENCION Y TE	57,04€



CODIGO	MATERIAL	P.V.P.
6VRMM34	VALV. RETENCION M/M 3/4	10 €
6VRMM1	VALV. RETENCION M/M 1"	14 €



CODIGO	MODELO	P.V.P.
6311A	¾ - ¾ CONTADOR 15 mm	36,67 €
6312A	¾ - 7/8 CONTADOR 13 mm	36 €



CODIGO	MODELO	P.V.P.
61278	½ - 7/8	6,19 €
61234	½ - ¾	4,70 €
6341	¾ - 1"	7,30 €

VÁLVULAS Y ACCESORIOS



CODIGO	MATERIAL	P.V.P.
632	A. CINCADO	5,40 €



CODIGO	MATERIAL	P.V.P.
631	A. GALVA.	45 €
631I	INOX	60 €
631P	PPR	80 €



CODIGO	MODELO	P.V.P.
613450	CONEXIÓN MALLA INOX M/H ¾ 50cm	15 €



CODIGO	MODELOS	P.V.P. BRIDA
6034	¾	12 €
60114	1 ¼	25 €
60112	1 ½	28 €
602	2 "	35 €
60212	2 ½	38 €
603	3"	45 €
604	4"	49 €



CODIGO	MATERIAL	P.V.P.
6ETI	PLASTICO	0,60 €
6ETI2	ALUMINIO 2 FILAS	13 €
6ETI3	ALUMINIO 3 FILAS	17 €



CODIGO	1 SERVICIO	P.V.P.
91	METALICO 350 X 600 X 250 mm	214 €
91 P	POLIÉSTER 430 X 315 X 180 mm	210 €

CODIGO	2 SERVICIOS	P.V.P.
92	METALICO 640 X 600 X 250 mm	349 €
92 P	POLIÉSTER 578 X 698 X 234 mm	360 €



CODIGO	3 SERVICIOS	P.V.P.
93	METALICO 820 X 600 X 250 mm	444 €

CODIGO	4 SERVICIOS	P.V.P.
94	METALICO 1000 X 600 X 250 mm	576 €

OTRAS MEDIDAS, CONSULTAR



CODIGO	1 SERVICIO	P.V.P.
91 M	METALICO 310 X 430 mm	60 €
91 PM	POLIÉSTER 430 X 315 mm	95 €

CODIGO	2 SERVICIOS	P.V.P.
92 M	METALICO 440 X 430 mm	70 €
92 PM	POLIÉSTER 578 X 698 mm	198 €



CODIGO	3 SERVICIOS	P.V.P.
93 M	METALICO 620 X 430 mm	85 €

CODIGO	4 SERVICIOS	P.V.P.
94 M	METALICO 800 X 430 mm	110 €

*OTRAS MEDIDAS, CONSULTAR

BANCADAS



CODIGO	MEDIDAS	P.V.P.
24030	40X30	50 €
26040	60X40	70 €
28050	80X50	95 €
210065	100X65	130 €
214065	140X65	140 €

PLACA SOPORTE MOTOR



CODIGO	MODELO	P.V. P
29SM	SOPORTE MOTOR BOMBA	50 €
29SMP	SOPORTE MOTOR PARED	68 €

COLECTORES PARA BOMBAS EN ACERO INOXIDABLE



CODIGO	DESCRIPCION	PVP
29211411	COLECTOR INOX 2 X 1 ¼ X 1 BOMBA 20CM	54 €
2911212	COLECTOR INOX 1 ½ X 1" x 2 BOMBAS 60 CM	94 €
2921142	COLECTOR INOX 2 X 1 1/4 X 2 BOMBAS 60CM	125 €
292121122	COLECTOR INOX 2 1/2 X 1 1/2 X 2 BOMBAS 60CM	142 €
2931143	COLECTOR INOX 3" X 1 1/4 X 3 BOMBAS 90CM	159 €
29322	COLECTOR INOX 3" X 2" X 2 BOMBAS 60CM	155 €
29323	COLECTOR INOX 3" X 2" X 3 BOMBAS 90CM	215 €



BAJANTES CON CARA O LISA



ADORNO GRABADO EN TUBO



ANCLAJE PARED OCULTO DETRÁS

CODIGO	BAJANTES DE 80 – 90 mm	P.V.P.
990	80 –90 SIN CODO	225 €
990C	80 – 90 CON CODO	243 €

CODIGO	BAJANTES DE 100 – 110 mm	P.V.P.
9110	100 – 110 SIN CODO	277 €
9110C	100 – 110 CON CODO	305 €

CODIGO	LISAS 80 – 90 Y 100 – 110 mm	P.V.P.
990L	80 - 90	163 €
9110L	100 - 110	237 €

*LAS BAJANTES LISAS NO LLEVAN NINGUN TIPO DE ADORNO NI GARRAS

FABRICADAS CON TUBO GALVANIZADO



*MEDIDAS: 1,92m SIN CODO; 2,05m CON CODO

*PARA OTRAS MEDIDAS, DISEÑOS, CANTIDADES U OTRAS CONDICIONES CONSULTAR.

LA EMPRESA NO SE RESPONSABILIZA DE LAS BAJANTES QUE ESTEN CONECTADAS DIRECTAMENTE AL ALCANTARILLADO



POLIG. "Q" C/ PARTIDA MATERNA Nº1
46.600 ALZIRA (VALENCIA)
TELF. 96 240 03 69 - MOVIL 638 05 83 95

pedidos@bateriascenteno.com

bateriascenteno@gmail.com